

# ALISMA-CT

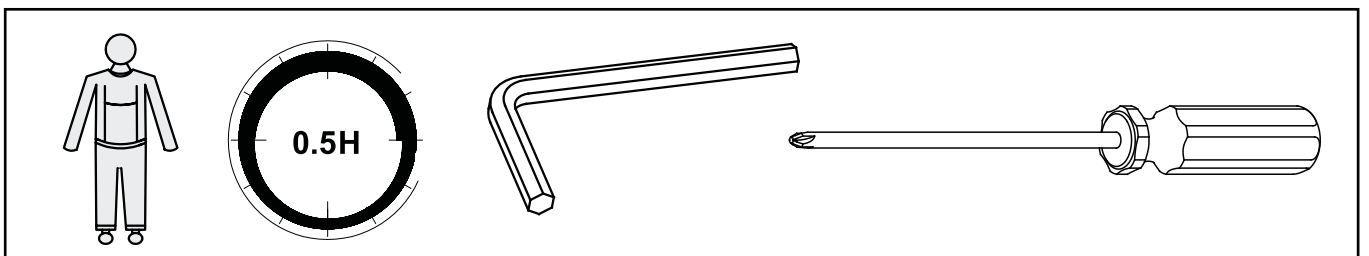

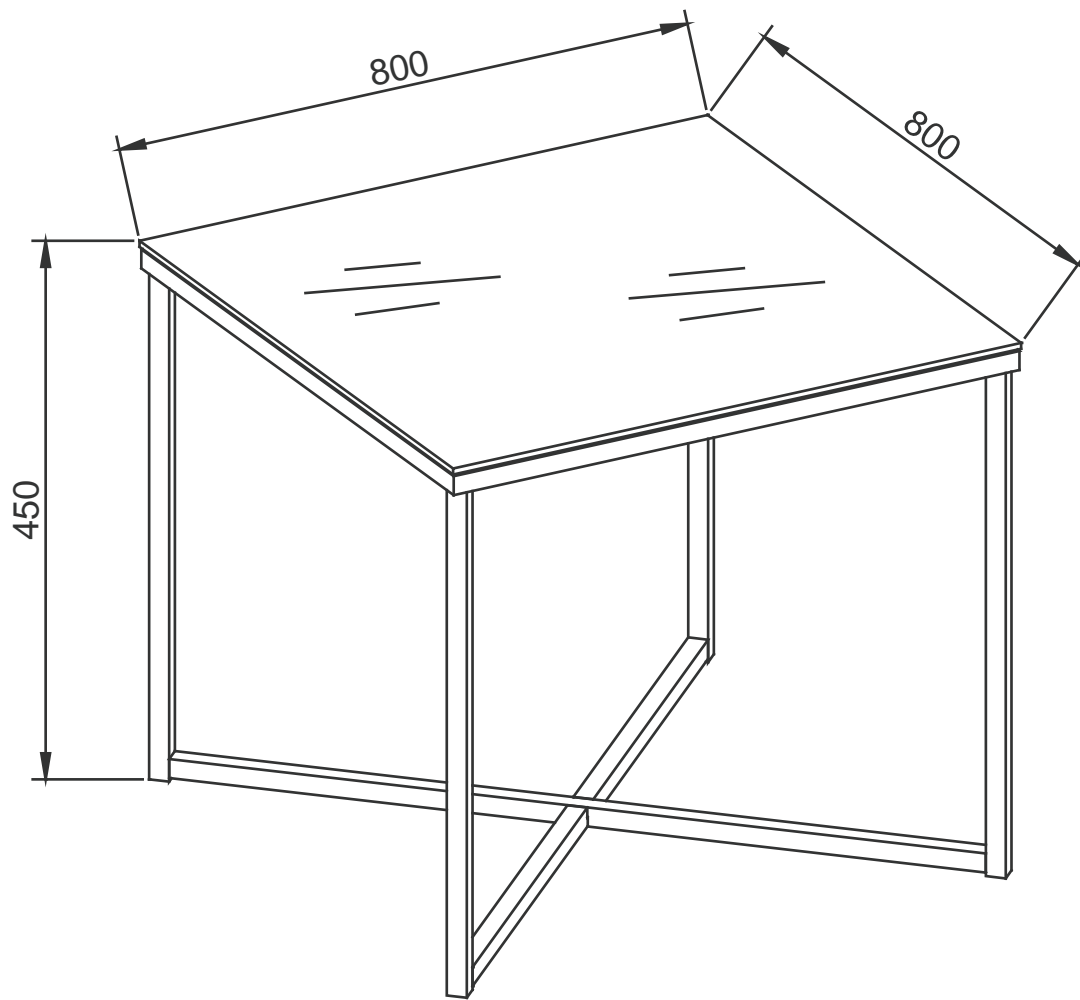

M4x10  
Ax4

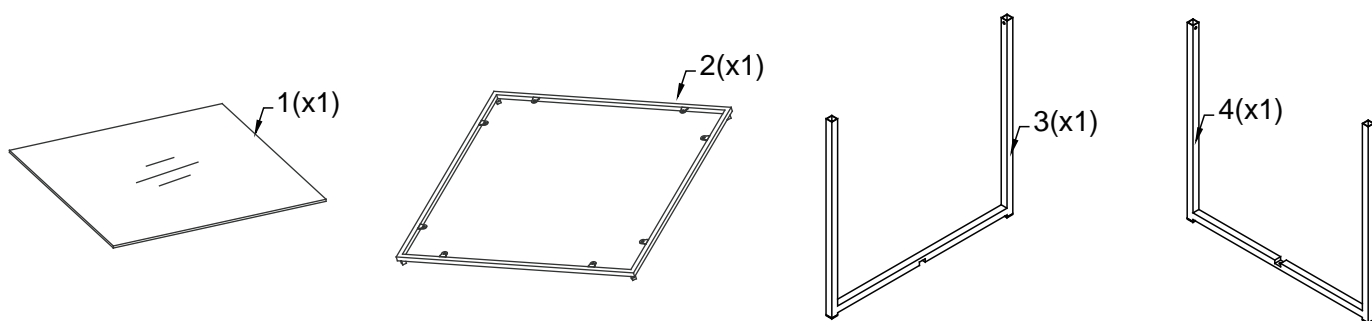
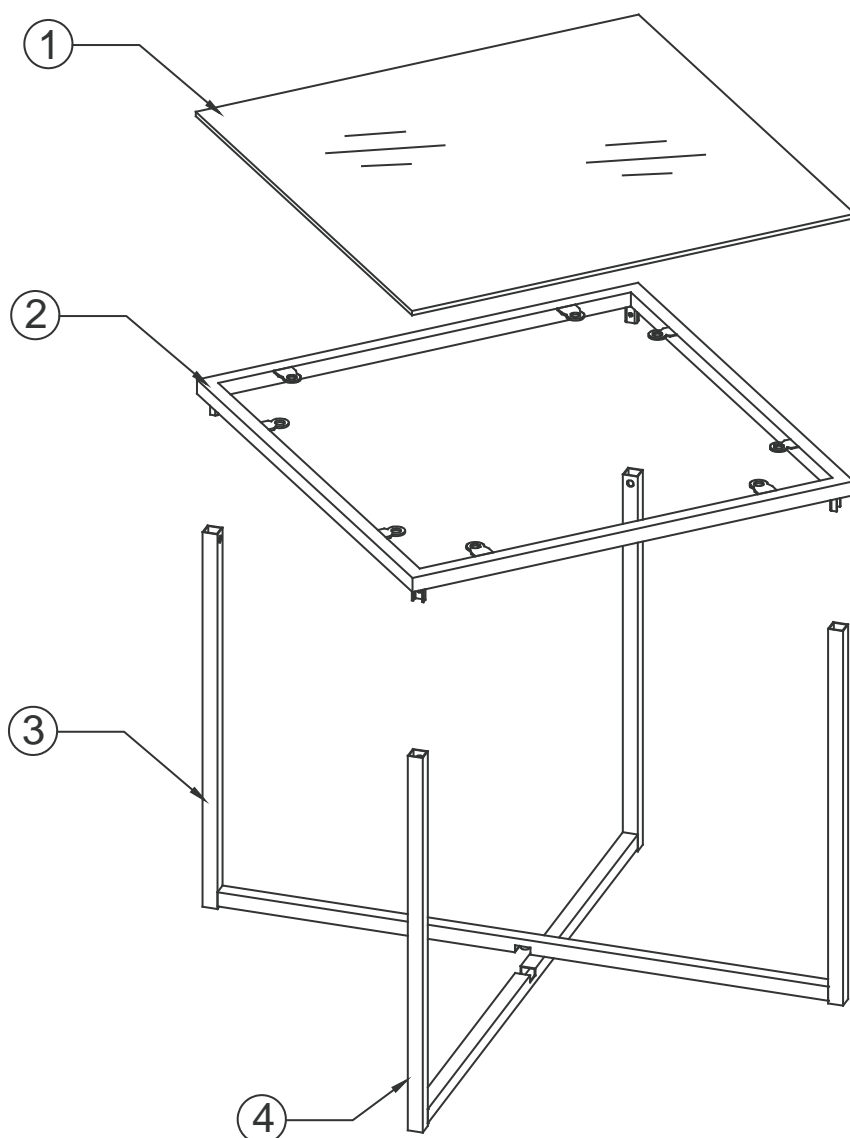

M6x8  
Bx1



Ø30  
Cx8



4MM  
Dx1



