

VCM.

service@vcm-gruppe.de

VCM Waschmaschinenüberbau "Jutas"

1,90m/ 0,64m/ 0,25m

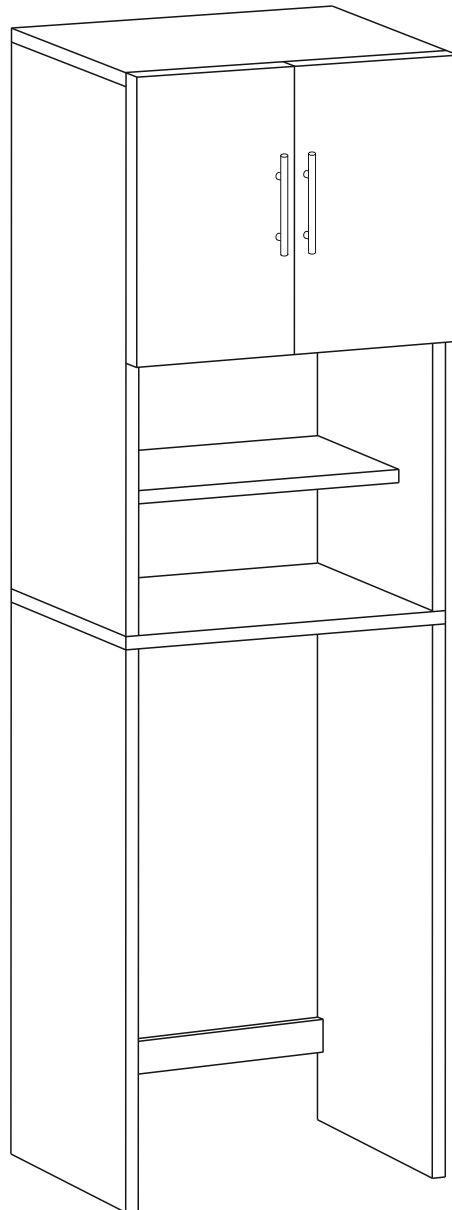

Achtung: Bei mangelhafter Montage besteht Gefahr für die Sicherheit.
Möbel unbedingt an der Wand montieren!!!!

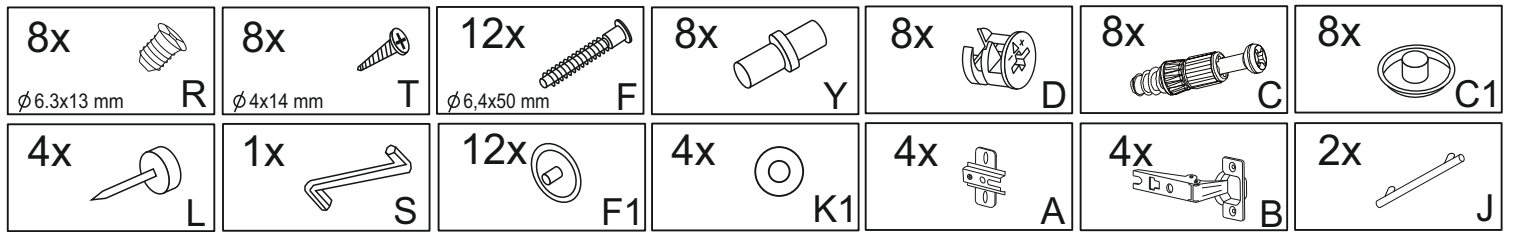

**Achtung! Verschluckbare Kleinteile enthalten.
Erstickungsgefahr. Kinder nicht unbeaufsichtigt in
der Nähe des Möbelstückes lassen.
Warning! Swallowable small parts enclosed.
Danger of suffocation. Do not leave children
unattended near furniture.**

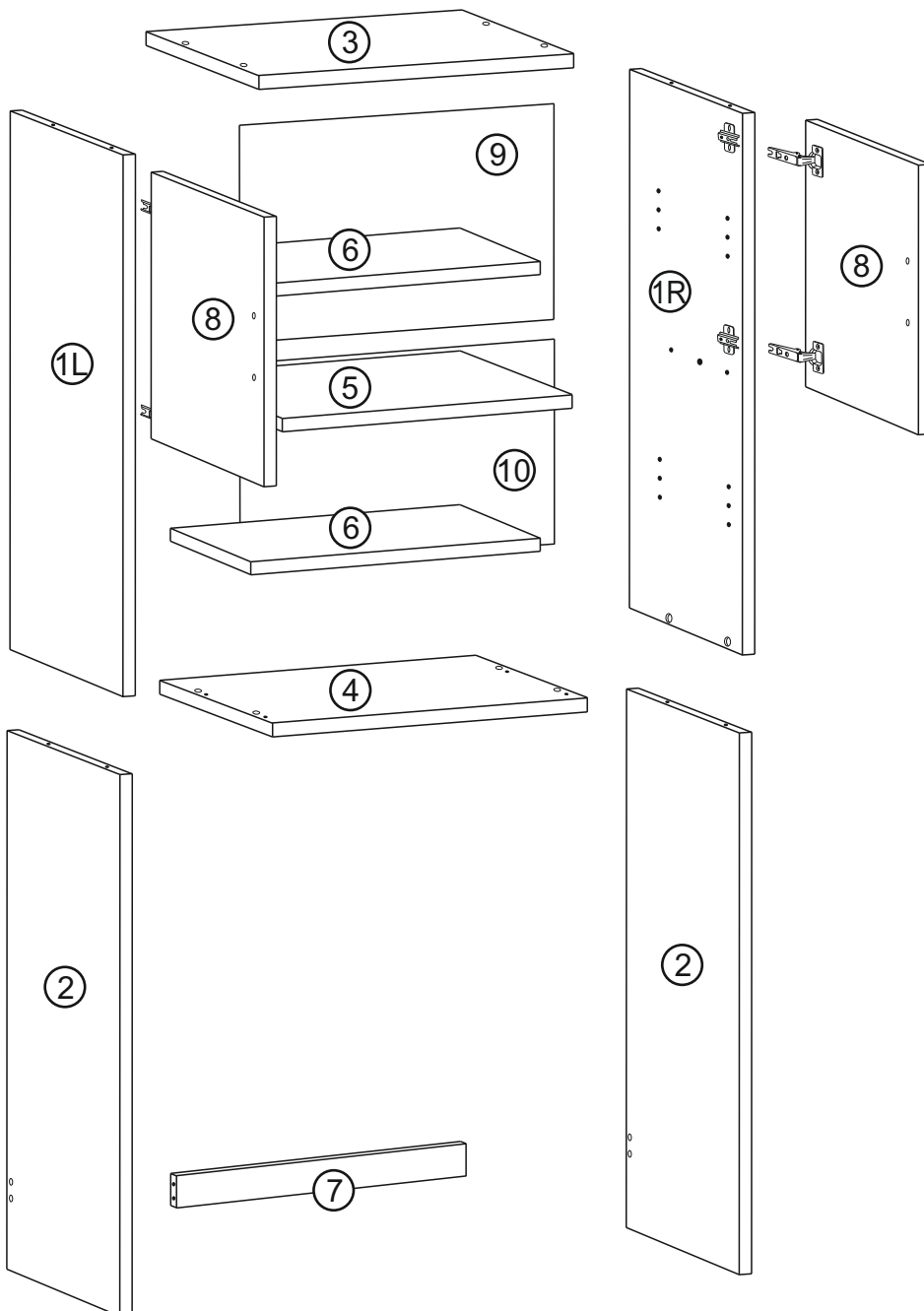
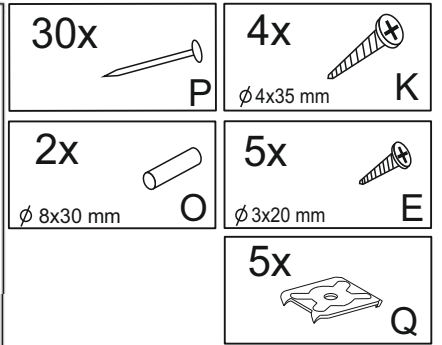

1L,1R	932x250x16
2,2	932x250x16
3,4	642x250x16
5	608x250x16
6,6	608x234x16
7	608x108x16
8,8	496x316x16
9	486x636
10	474x636

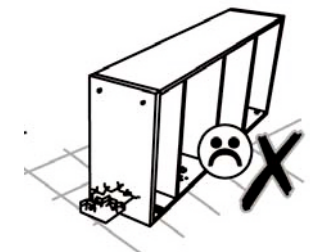
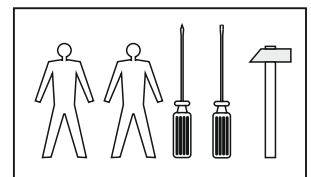

1

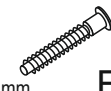
4x  F
 ϕ 6,4x50 mm

4x  F1

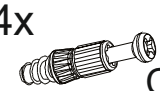
4x  C

4x  A

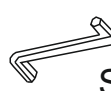
1x  S

8x  R
 ϕ 6.3x13 mm

8x  O
 ϕ 8x30 mm

4x  D

8x  C1

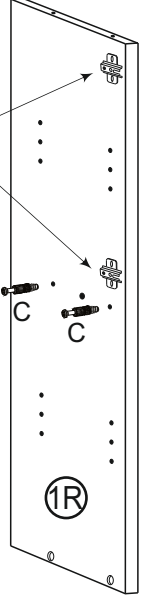
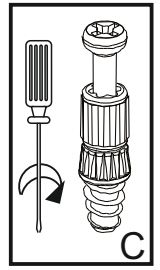
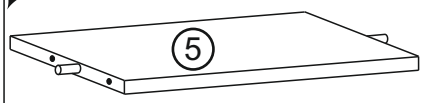
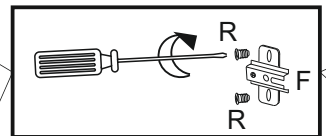
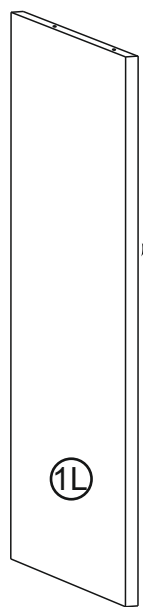
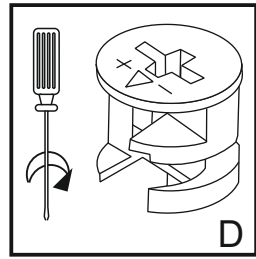
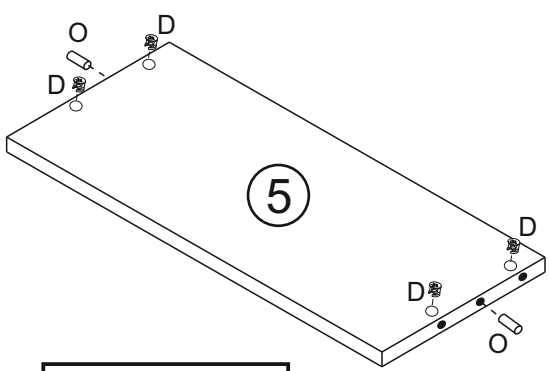
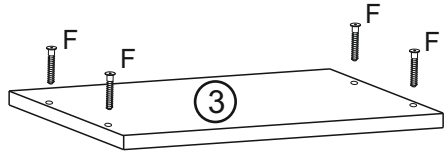
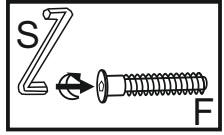

2

8x  F
 ϕ 6,4x50 mm

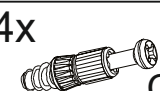
4x  C

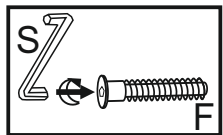
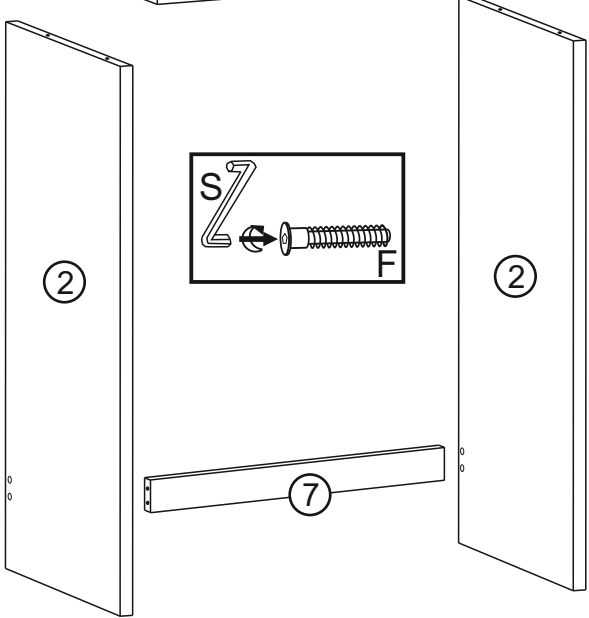
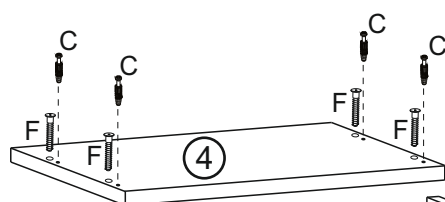
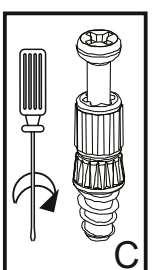

3

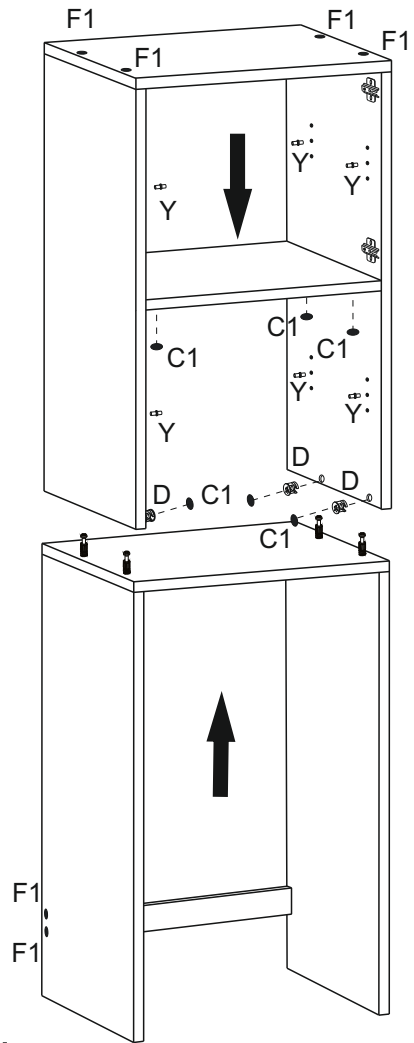

4x  D

8x  C1

8x  F1

8x  Y

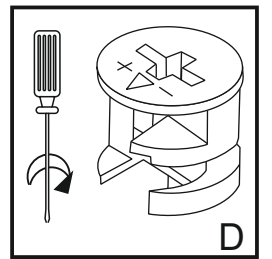

4

4x



5x



30x



5x

ø3x20 mm

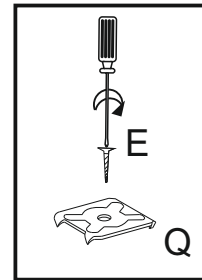
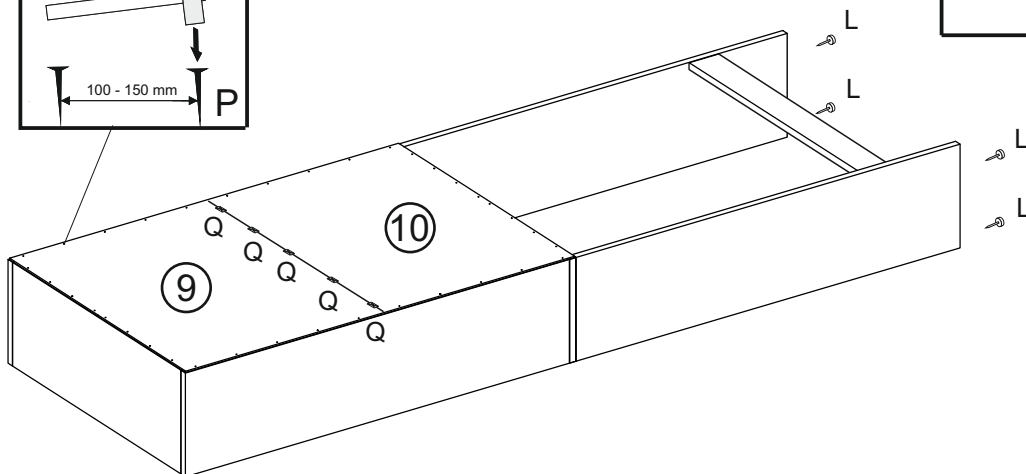
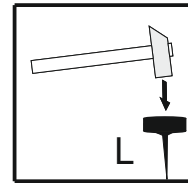
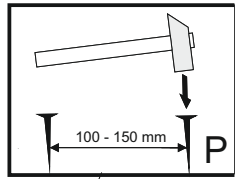
**5**

4x

ø4x35 mm

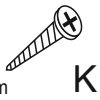

2x

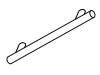

4x

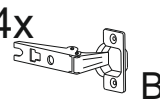

8x

ø4x14 mm



4x

